

# Slotted Optical Switch OPB804

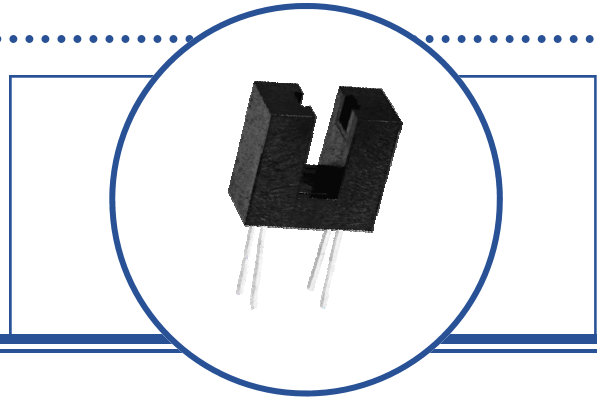

## Features:

- Non-contact switching
- Housing opaque material
- Printed circuit board mount
- 0.155" (3.9 mm) width gap, 0.330" (8.4 mm) depth slot



## Description:

**OPB804** contains an IRLED and phototransistor paired in an opaque plastic housing .

The housing is an opaque grade of injection molded plastic, which minimizes the assembly's sensitivity to visible and near-infrared radiation. A wide open aperture [0.06" (1.5mm) equivalent] makes it versatile for general applications.

The output phototransistor turns off when an object opaque to IR (700 nm to 1100 nm) is inserted into the gap between the emitter and sensor, thereby interrupting the light beam.

Contact OPTEK for special electrical screening, value-added services and next-level-assembly services on this sensor.

## Applications:

- Non-contact object sensing
- Assembly line automation
- Machine automation
- Equipment security
- Machine safety

Ordering Information					
Part Number	LED Peak Wavelength	Sensor	Slot Width / Depth	Aperture Emitter/Sensor	Lead Length / Spacing
OPB804	935 nm	Transistor	0.155" / 0.330"	None	0.425" / 0.300"

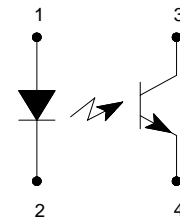
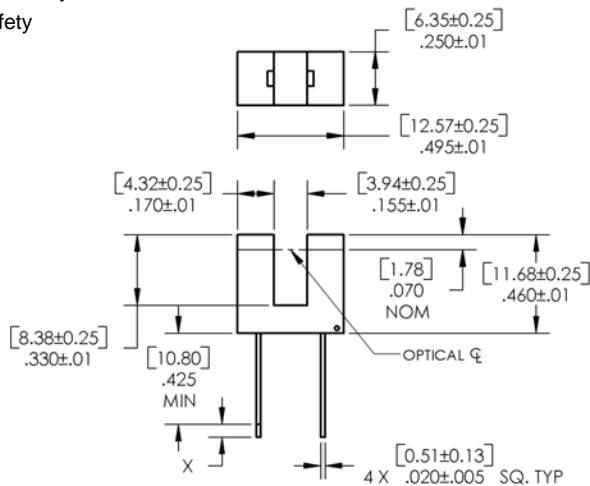

Pin #	LED	Pin #	Transistor
1	Anode	3	Collector
2	Cathode	4	Emitter



RoHS

OPTEK reserves the right to make changes at any time in order to improve design and to supply the best product possible.

**Absolute Maximum Ratings** ( $T_A=25^{\circ}\text{C}$  unless otherwise noted)

Storage Temperature Range	-40°C to +100°C
Operating Temperature Range	-40°C to +85°C
Lead Soldering Temperature [1/16 inch (1.6mm) from the case for 10 sec. with soldering iron] <sup>(1)</sup>	260°C for 5 Seconds

**Input IRLED**

Forward DC Current	50 mA
Peak Forward Current (1 $\mu\text{s}$ pulse width, 300 pps)	1 A
Reverse DC Voltage	2 V
Power Dissipation	75 mW

**Output Phototransistor**

Collector-Emitter Voltage	30 V
Emitter-Collector Voltage	5 V
Collector DC Current	30 mA
Power Dissipation	100 mW

**Electrical Characteristics** ( $T_A = 25^{\circ}\text{C}$  unless otherwise noted)

SYMBOL	PARAMETER	MIN	TYP	MAX	UNITS	TEST CONDITIONS
--------	-----------	-----	-----	-----	-------	-----------------

**Input Diode** (see OP140 for additional information)

$V_F$	Forward Voltage	-	1.25	1.7	V	$I_F = 20 \text{ mA}$
$I_R$	Reverse Current	-	-	100	$\mu\text{A}$	$V_R = 2 \text{ V}$

**Output Phototransistor** (see OP550 for additional information)

$V_{(BR)CEO}$	Collector-Emitter Breakdown Voltage	30	-	-	V	$I_C = 1 \text{ mA}, E_E = 0 \text{ mw/cm}^2$
$V_{(BR)ECO}$	Emitter-Collector Breakdown Voltage	5	-	-	V	$I_E = 100 \mu\text{A}, E_E = 0 \text{ mw/cm}^2$
$I_{CEO}$	Collector-Emitter Dark Current	-	-	100	nA	$V_{CE} = 10 \text{ V}, I_F = 0, E_E = 0 \text{ mw/cm}^2$

**Combined**

$V_{CE(SAT)}$	Collector-Emitter Saturation Voltage	-	-	0.4	V	$I_C = 250 \mu\text{A}, I_F = 20 \text{ mA}$
$I_{C(ON)}$	On-State Collector Current	0.5	5	-	mA	$V_{CE} = 10 \text{ V}, I_F = 20 \text{ mA}$

Notes:

1. With soldering iron 1/16 inch (1.6mm) from the case. Duration can be extended to 10 seconds max. when flow soldering. RMA flux is recommended.
2. All parameters measured using pulse technique.
3. Derate linearly 1.25 mW/°C above 25 ° C.

OPTEK reserves the right to make changes at any time in order to improve design and to supply the best product possible.

**OPB804 - Flag Next to Emitter**

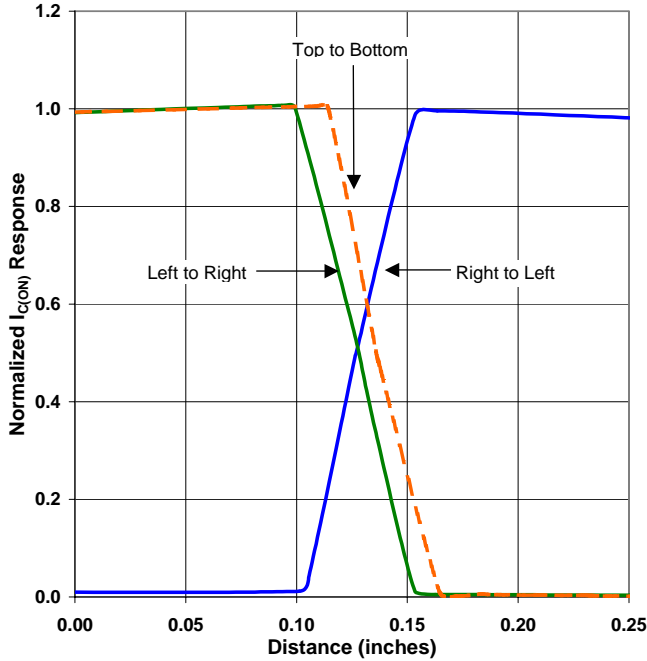

**OPB804 - Flag Next to Sensor**

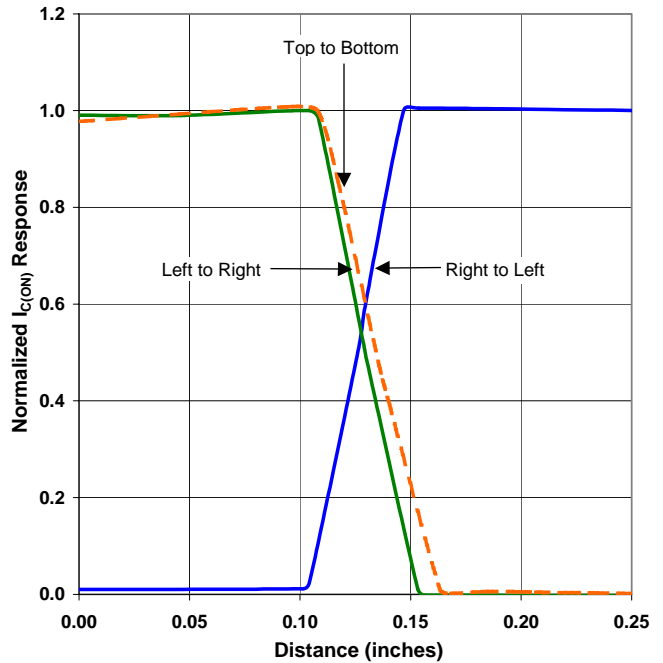

**OPB804 - Flag in Middle of Slot**

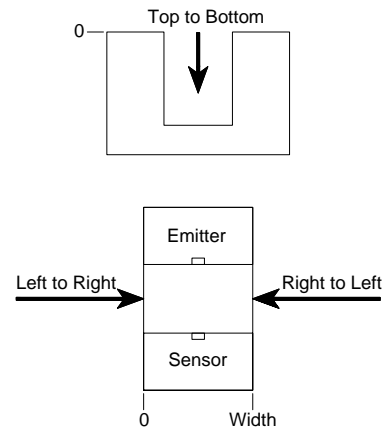
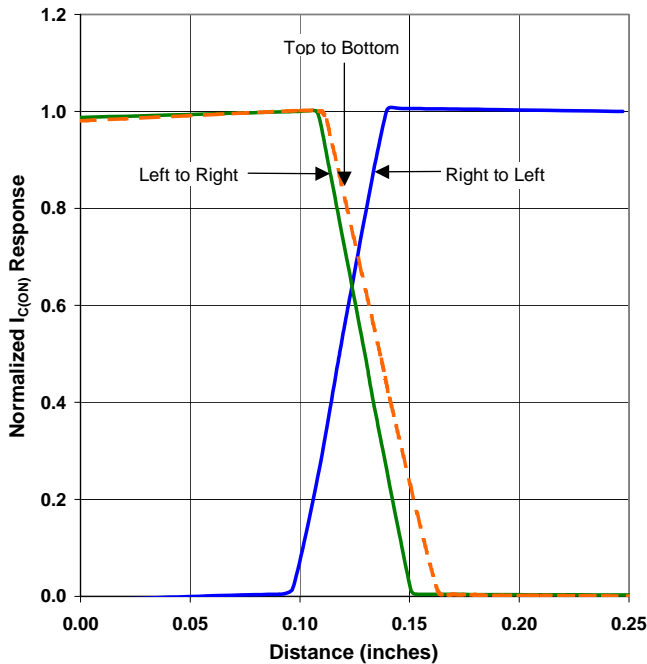

OPTEK reserves the right to make changes at any time in order to improve design and to supply the best product possible.